

AC25

Vulcanizers for Rubber Conveyor Belts > Portable presses > Air-cooled

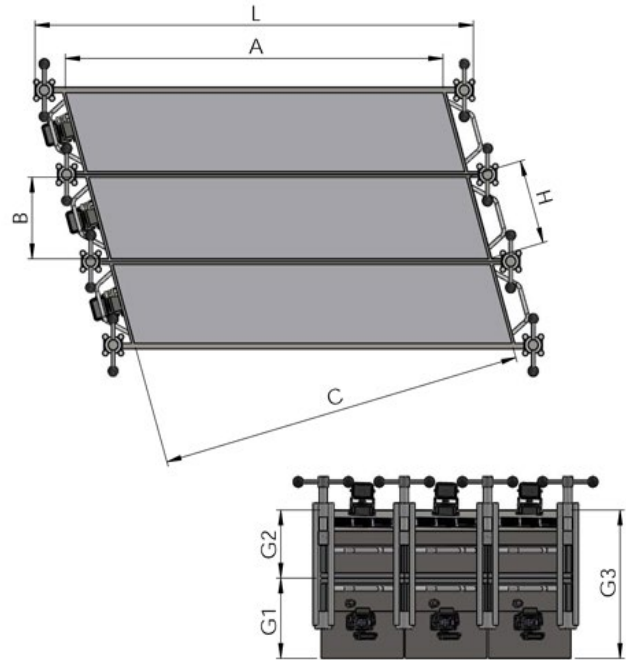
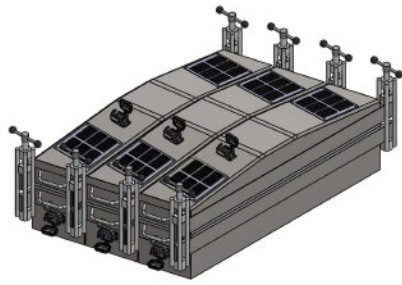

Material	Mild Steel
Pressure	Hydraulic cylinders 7 Bar (100PSI) / 14 Bar (200PSI)
Heating	Heating Elements 185°C Max.
Cooling	Air
Belt Width	Up to 2400mm
Platen length	250mm per section
Angle	16° - 22°

Technical data correspond to the 16° models.

Model	Belt mm	G1 mm	G2 mm	G3 mm	A mm	B mm	C mm	H mm	L mm	Lower frame weight Kg	Upper frame weight Kg	Total weight Kg
AC25 600	600	170	180	350	730	250	702	260	890	34	47	81
AC25 650	650	170	180	350	780	250	750	260	940	39	54	93
AC25 800	800	190	200	390	930	250	894	260	1100	55	71	126
AC25 1000	1000	190	200	390	1145	250	1101	260	1310	65	94	159
AC25 1200	1200	220	200	420	1350	250	1298	260	1510	74	100	174
AC25 1400	1400	235	225	460	1550	250	1490	260	1760	105	150	255
AC25 1600	1600	290	280	570	1750	250	1682	260	1970	139	188	327
AC25 1800	1800	290	280	570	1950	250	1874	260	2280	169	219	388
AC25 2000	2000	290	280	570	2150	250	2067	260	2430	194	252	446
AC25 2200	2200	305	285	590	2350	250	2302	260	2580	229	288	517
AC25 2400	2400	315	275	590	2550	250	2499	260	2780	261	324	585

The technical data shown are subject to change without notice.